



21347
(10351052)
White Nylon

Trim Panel Grommet with Sealer
Head Size: 12mm x 14.5mm
Stem Length: 15mm
Fits into 7mm Hole
Mates with Auveco 21346
Cadillac, Chevrolet Camaro &
Corvette and Pontiac Firebird 2004 - On

UNIT PACKAGE: 15



17271
(94113207)
Natural Nylon

Cowl Cover Retaining Clip
Head Diameter: 23mm
Chevrolet Spectrum 1989-85

UNIT PACKAGE: 15



19247
(10262143)
Black Nylon

Air Intake Grille Panel Grommet
For 5mm Stud
Buick Regal & Century Chevrolet Lumina
& Monte Carlo, Oldsmobile Cutlass,
Pontiac Grand Prix 1996-On

UNIT PACKAGE: 25



19194
(Toyota: 90189-06028; GM: 94854203)
Black Nylon

Front & Rear Wheel
Fender Liner Screw Grommet
Screw Size: #12
Head Diameter: 16mm
Stem Length: 19mm
Fits into 9mm x 9mm Square Hole
Tacoma, T100 & 4 Runner 1992 - On
Chevrolet Nova & Prizm
and Pontiac Vibe 1985 - On

UNIT PACKAGE: 15



19676
(10277480)
Natural Nylon

License Plate Cover
Screw Grommet
Screw Size: M4.2 (#8)
Head Diameter: 9/16"
Stem Length: 9/16"
Fits into 1/4" Square Hole
Oldsmobile Intrigue 1998 - On

UNIT PACKAGE: 15



17230
(10027015)
Natural Nylon

Screw Grommet for
Engine Control Module
Overall Length: 1-3/16"
GM (All Divisions) 1977-On

UNIT PACKAGE: 10



20938
(11561655)
Black Nylon

Tail Light Grommet with Sealer
Head Diameter: 15mm
Stem Length: 17mm
Fits into 11mm Hole
Buick Terraza, Chevrolet Uplander, GMC
Arcadia, Pontiac Montana SV6
and Saturn Relay 2005 - On

UNIT PACKAGE: 5



22026
(GM: 25803643)
Natural Nylon

Door Glass to Regulator Grommet
Head Diameter: 13.5mm
Overall Length: 14mm
Buick Allure, LaCrosse & Verano and
Chevrolet Malibu 2010 - On

UNIT PACKAGE: 25



21674
(11570830)
White Nylon

Fog Light Grommet
Head Diameter: 16mm
Stem Length: 16mm
Overall Length: 20mm
Fits into 11mm Hole
Cadillac Escalade, Chevrolet Avalanche, Camaro,
Colorado, Silverado & Tahoe and GMC
Canyon, Denali, Sierra & Yukon 2005 - On

UNIT PACKAGE: 15



19429
(15954398)
Rubber

Tail Light Screw Grommet
Venture, Silhouette, Transport,
S & T Trucks 1995-On

UNIT PACKAGE: 25



12713
(GM: 10032838, 1264963;
Chry: 6031869; AMC: 8934-201-602)
Nylon

High Torque Screw Grommet
Screw Size: #6
GM, Chrysler & AMC-Renault 1978-On

UNIT PACKAGE: 25



11865
(GM: 1255823; Ford: 389360S)
Natural Nylon

Front End Bezel Nut
Screw Size: #6 or #8
GM 1979-On
Tail Light Nut
Ford 1981-On

UNIT PACKAGE: 50



10365
(1377030)
Natural Nylon

Valance Panel to Rear
Bumper Bar Grommet
Screw Size: #6 or #8
GM 1971-On

UNIT PACKAGE: 100



20452
(11517873)
Natural Nylon

Screw Grommet
Use with #12 Screw
Head Size: 5/8" x 3/4"
Stem Length: 9/16"
Door Handle
Chevrolet Impala & Monte Carlo 2000 - On

UNIT PACKAGE: 15



19435
(25526447)
Natural Nylon

Radiator Screw Grommet
Screw Size: #6
Buick Century 1996 - 86

UNIT PACKAGE: 50



14009
(14032291)
Natural Nylon

Grille Attachment Grommet
Screw Size: #6 or #8

UNIT PACKAGE: 50



21428
(25704358)
White Nylon

Rear Bumper Screw Grommet with Sealer
Screw Size: M6.3 (1/4" or #14)
Head Size: 15mm x 18mm
Stem Length: 23mm
Cadillac CTS & SRX and
Pontiac Grand Prix 2004 - On

UNIT PACKAGE: 10



14220
(25525798, 22537749)
Natural Nylon

Grille Retaining Grommet
Screw Size: #8
GM 1985-On

UNIT PACKAGE: 50



14037
(GM: 15596280; Chry: 6035274)
Black Nylon

Cowl Vent Nut
Screw Size: #6 or #8
GM Astro & Safari 1985-On

UNIT PACKAGE: 25



20466
(GM: 25649667;
Ford: W705590-S300, W710459-S300)
Natural Nylon

Screw Grommet with Sealer
Screw Size: M4.2 (#8)
Head Size: 13mm x 22mm
Stem Length: 18mm
Back Glass Moulding & Interior Trim
Cadillac & Ford Windstar 1998 - On

UNIT PACKAGE: 15



12566
(GM: 25508532; Chry: 6032061)
Black Nylon

Grille Attaching Grommet
Screw Size: #6 or #8
GM & Chrysler 1981-On

UNIT PACKAGE: 25



19732
(22615352)
Black Nylon

Front Bumper Fascia
Hinged Pin Retainer
Assembles with Auveco 19733
Pontiac Grand Am 1999 - On

UNIT PACKAGE: 15



20635
(GM: 22722860)
White Nylon

Trim Panel Grommet with Sealer
Flange Diameter: 24mm
Stem Length: 12mm
Fits into 9mm Hole
Use with Auveco 20634
Oldsmobile Alero &
Pontiac Grand Am 2002 - On

UNIT PACKAGE: 25



21384
(11561500)
Yellow Nylon

Trim Panel Grommet with Sealer
Flange Diameter: 24mm
Stem Length: 12mm
Fits into 9mm Hole
Use with Auveco 21383
Chevrolet Traverse 2010 - On

UNIT PACKAGE: 25



20527
(15745990)
Black Nylon

Rear Light Housing
Lower Grommet
Head Size: 24mm x 24mm
Stem Length: 17mm
Fits into 15mm Hole
GM Bravada, Envoy &
Trailblazer 2002 - On

UNIT PACKAGE: 15



20529
(15745991)
Black Nylon

Rear Light Housing
Upper Grommet
Head Size: 13mm x 20mm
Stem Length: 17mm
Fits into 9mm x 16mm Hole
GM Bravada, Envoy
& Trailblazer 2002 - On

UNIT PACKAGE: 15



21518
(11561987)
Black Nylon

Tail Light Grommet with Sealer
Head Diameter: 24mm
Stem Length: 22mm
Overall Length: 24.5mm
Cadillac Escalade and
Chevrolet Avalanche 2007 - On

UNIT PACKAGE: 15



19613
(15733971)
Black Nylon

Front Air Deflector Retainer
Top Head Diameter: 18mm
Bottom Head Diameter: 26mm
Flange Diameter: 30mm
Stem Length: 24mm
Use with Auveco 19614
C & K Trucks 1999 - On

UNIT PACKAGE: 15



19614
(15733970)
Black Nylon

Front Air Deflector Grommet
Head Diameter: 28mm
Stem Length: 13mm
Use with Auveco 19613
C & K Trucks 1999-On

UNIT PACKAGE: 25



17128
(10119853)
Nylon

Body Side & End Gate
Lower Moulding Clip
Olds Custom Cruiser 1991-On

UNIT PACKAGE: 25

13925
(20338568)
Nylon



Outer Panel Front of Rear
Wheel Opening Moulding Clip
GM 1982-On

UNIT PACKAGE: 10



18911
(22578985)
Nylon

Rocker Panel
Moulding Clip
Buick Skylark 1993-On

UNIT PACKAGE: 10



17545
(22550254)
Nylon

Rocker Panel
Moulding Clip
Pontiac Grand Am SE 1992-On

UNIT PACKAGE: 25

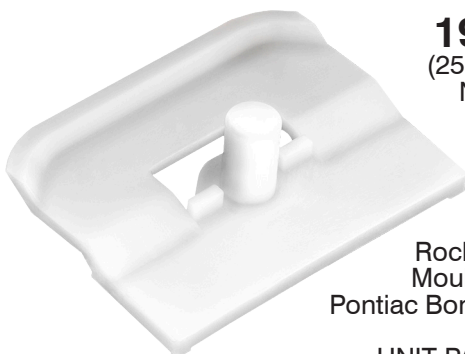

19361
(25554845)
Nylon

Rocker Panel
Moulding Clip
Pontiac Bonneville 1992-On

UNIT PACKAGE: 20

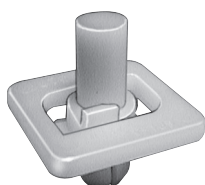

19410
(10261327)
Nylon

Front & Rear Door
Lower Moulding Clip
Buick Century, Regal & Rendezvous
and Pontiac Aztek & Grand Prix 1997-On

UNIT PACKAGE: 15

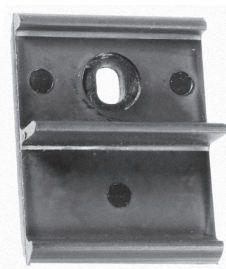

11138
(6263345)
Nylon

Body Side Moulding Clip
Use with 1/8" Pop Rivet
GM Trucks 1968-On

UNIT PACKAGE: 10



11485
(1729250)
Nylon

Roof Transverse Moulding Clip
GM 1976-On

UNIT PACKAGE: 25

**Please place orders in
Unit Package quantities,
not based on pieces needed**

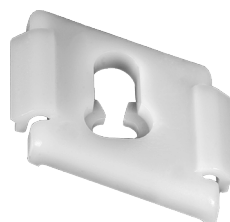

14946
(20606417)
Nylon

Left Outer Panel in Front of Rear
Wheel Opening Moulding Clip
Width: 7/8"
Length: 1-3/16"
Pontiac Bonneville 1989-87

UNIT PACKAGE: 25



10220
(4457595, 4457495)
Nylon

Quarter Belt &
Wheel Opening Moulding Clip
GM 1967 -On

UNIT PACKAGE: 50



11288
(9838109)
Gray Nylon

Body Side Moulding Clip
Buick, Chevrolet & Oldsmobile 1967-On

UNIT PACKAGE: 100



18118
(10135796)
Nylon

Body Side Moulding Clip
Buick Roadmaster 1991-On

UNIT PACKAGE: 15

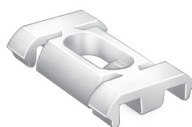

12563
(20175051, 15633873)
Nylon

Quarter Belt Reveal Moulding Clip
GM 1980-On

UNIT PACKAGE: 50



11425
(1688094)
Nylon

Vinyl Top Clip
Used on narrow Moulding across top of roof
Chevrolet, Cadillac & Oldsmobile 1974-On

UNIT PACKAGE: 50



12594
(20171942)
Nylon

Moulding Clip
GM 1980-On

UNIT PACKAGE: 25



11717
(1660123)
Nylon

Belt Moulding Clip
GM 1975-On

UNIT PACKAGE: 50



12602
(20237057)
Nylon

Moulding Clip
GM 1980-On

UNIT PACKAGE: 25

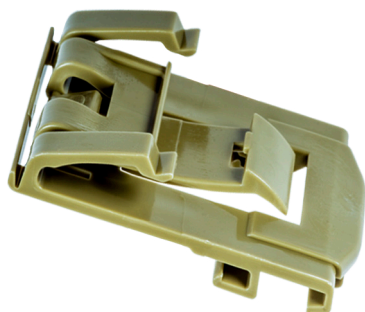

22228
GM: 11547339)
Pale Green Nylon

Belt Moulding Clip
Width: 26mm
Length: 43mm
Chevrolet Silverado &
Tahoe and GMC Sierra
2014 - On

UNIT PACKAGE: 15



12621
(14022878)
Nylon

Moulding Clip
GM 1980-On

UNIT PACKAGE: 25



9850
(7731589)
Natural Nylon

Quarter Panel Reveal Moulding &
Landau Top Moulding Clip
Use with Auveco 9877
GM

UNIT PACKAGE: 100



14642
(20199675)
Nylon

Quarter Belt Reveal Moulding Clip
Width: 7/16"
Length: 31/32"
GM 1980-On

UNIT PACKAGE: 50



10617
(8799350)
Nylon

Door, Quarter Panel & Rear End Moulding Clip
GM 1970-On

UNIT PACKAGE: 50



12824
(20274997)
Nylon

Rear Quarter Reveal Moulding Clip
GM 1980-On

UNIT PACKAGE: 50



17219
(21093588)
Nylon

Roof Drip
Moulding Clip
2 Door & 4 Door Models
GM Saturn 1991-On

UNIT PACKAGE: 25

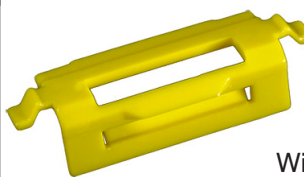

20232
(10287926)
Yellow Nylon

Front & Rear Door
Window Moulding Clip
Overall Length: 1-9/16"
Buick Century & Regal
and Oldsmobile Intrigue 1997 - On

UNIT PACKAGE: 25



10318
(8733059
4492962, 9838109)
Nylon

Body Side & Wheel Opening
Moulding Clip
Buick, Chevrolet & Oldsmobile 1968-On

UNIT PACKAGE: 100

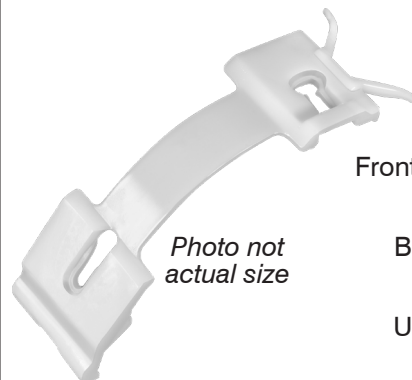

17979
(25552856)
Nylon

Front & Rear Door Center
Moulding Clip
Length: 4-3/8"
Buick LeSabre Ltd.
1992-On

*Photo not
actual size*

UNIT PACKAGE: 5

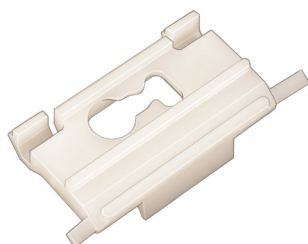

14033
(20393536)
Nylon

Front/Side Fender
Moulding Clip
GM Truck 1983-On

UNIT PACKAGE: 25

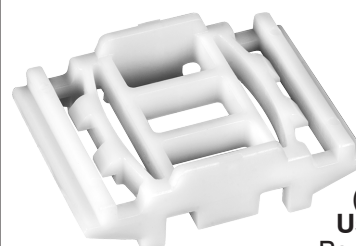

18417
(12519975)
Nylon

Front & Rear Door
Lower Finish Panel
(Lower) Moulding Clip
Use with Auveco 18421
Pontiac Bonneville 1992-On

UNIT PACKAGE: 15

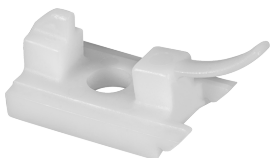

13458
(20444103)
Nylon

Door Moulding Clip
GM 1984-On

UNIT PACKAGE: 15



20578
(GM: 88970495, 88973654;
Toyota: 76924-52021)
Black Nylon

Rocker Moulding Retainer
Head Diameter: 32mm
Stem Length: 10mm
Fits into 22mm Hole
Pontiac Vibe & Toyota Corolla 2003 - On

UNIT PACKAGE: 25



13828
(GM: 1706200)

Quarter Belt Moulding Clip
Cadillac 1976-On

UNIT PACKAGE: 25



20263
(22599312)
Black Nylon

Front & Rear Door
Window Moulding Clip
Chevrolet Malibu, Oldsmobile
Achieva & Cutlass 1997 - On

UNIT PACKAGE: 25

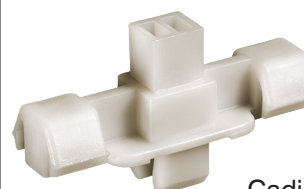

19358
(3526573)
Nylon

Front & Rear Door
Lower Moulding Clip
Cadillac DeVille & Seville 1997-92

UNIT PACKAGE: 10



18418
(16611889)
Nylon

Front Fender, Door
& Rear Quarter Panel
Center Moulding (Lower) Clip
Pontiac Grand Prix 1991-On

UNIT PACKAGE: 10



19411
(25630331)
Nylon

Front Door and
Front & Rear Fender
Moulding Clip
Pontiac Bonneville
1996-On

UNIT PACKAGE: 10



18428
(10167448)
Nylon

Rear Quarter Center Front
Moulding Clip
Excludes Deluxe Extra Trim
Olds Cutlass 1994-92

UNIT PACKAGE: 25

18423
(25552853)
Nylon

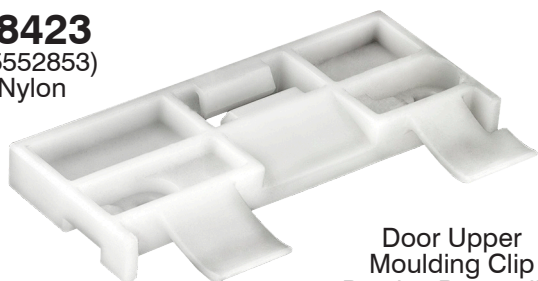

Door Upper
Moulding Clip
Pontiac Bonneville
1992-On

UNIT PACKAGE: 15

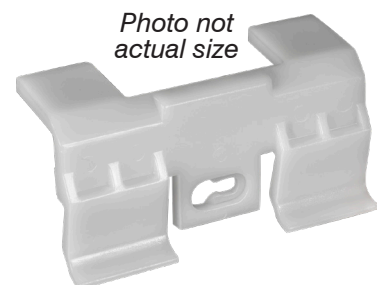

19357
(10167445)
Nylon

Rocker Quarter Panel
Moulding Clip
Oldsmobile Cutlass
Supreme 1997-92

UNIT PACKAGE: 15

19370
(16615006)
Nylon



Rocker Panel
Moulding Clip
Oldsmobile Aurora 1995-On

UNIT PACKAGE: 15



20280
(25648693)
Gray Nylon

Rocker Panel Moulding Clip
Width: 7/8"
Length: 2"
Cadillac DeVille &
Seville 1998 - On

UNIT PACKAGE: 10

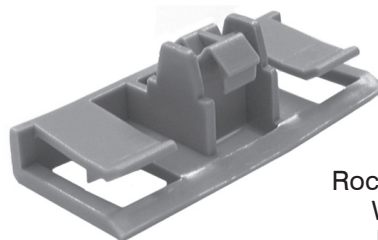

20318
(25722671)
Gray Nylon

Rocker Panel Clip
Width: 7/8"
Length: 2"
Buick LeSabre, Cadillac DeVille &
Seville, Oldsmobile Aurora and
Pontiac Bonneville 2000 - On

UNIT PACKAGE: 10

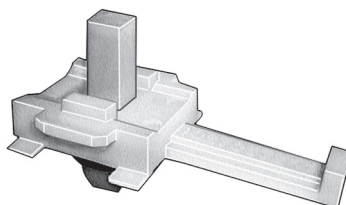

19390
(10270672)
Nylon

Rear Side Door
Lower Moulding Clip
Pontiac Trans Sport,
Montana 1997-On

UNIT PACKAGE: 10



18390
(10082288)
Black Nylon

Front Door
Moulding Retainer
Chevrolet Beretta, Corsica 1987-On

UNIT PACKAGE: 25



22224
(GM: 92139070)
White Nylon

Pillar Trim Moulding Clip
Width from Ear to Ear: 9.3mm
Bottom Width: 10.4mm
Overall Height: 15.5mm
Chevrolet Caprice & SS 2011 - On
Pontiac G8 2009 - 2008

UNIT PACKAGE: 25



22161
(GM: 94748652)
White Nylon

Quarter Panel & Exterior Trim
Moulding Clip
Width from Ear to Ear: 8mm
Overall Height: 15mm
Chevrolet Corvette Stingray
& Z06 2014 - On

UNIT PACKAGE: 25



22021
(Ford: W790225-S900)
Gray Nylon

Fender Corner &
Rocker Moulding Clip
Top Head Size: 16mm x 23mm
Bottom Head Diameter: 17mm
Stem Length: 12mm
Fits into 9mm Hole
Ford Focus 2012 - On

UNIT PACKAGE: 10

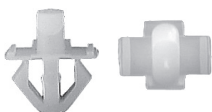

20408
(10287547)
White Nylon

Door & Rocker Panel Moulding Clip
Top Head Size: 3.5mm x 8mm
Bottom Head Size: 8.7mm x 12mm
Stem Length: 8mm
Fits into 8mm Hole
Buick Century, Regal &
Pontiac Grand Prix 1995 - On

UNIT PACKAGE: 25



15695
(Toyota: 62955-20020; GM: 94848834)
Nylon

Retainer with Sealer
Head Diameter: 15mm
Stem Length: 9mm
Fits into 8mm Hole
Toyota Pick-Up Truck, Pontiac Vibe

UNIT PACKAGE: 25



21316
(94530742)
White Nylon

Fender, Wheel, Side & Bumper
Moulding Clip with Sealer
Top Head Size: 11mm x 15mm
Bottom Head Diameter: 16mm
Stem Length: 10mm
Fits into 8mm Hole
Saturn Vue 2008 - On
Chevrolet Captiva & Cruze 2011 - On

UNIT PACKAGE: 15



21158
(11569920)
Green Nylon

Fender Moulding Clip with Sealer
Top Head Size: 7.5mm x 11mm
Bottom Head Size: 15mm x 15mm
Stem Length: 13mm
Fits into 7mm Hole
Buick Enclave, Cadillac CTS, Chevrolet
Traverse & GMC Acadia 2003 - On

UNIT PACKAGE: 10



21825
(GM: 11611375)
White Nylon

Moulding Clip with Sealer
Top Head Size: 8mm x 18mm
Bottom Head Diameter: 15mm
Stem Length: 13mm
Fits into 8mm Hole
Cadillac, Chevrolet & GMC 2014 - 13

UNIT PACKAGE: 15



22222
(GM: 92138865)
White Nylon

Body Side Moulding Clip
Top Head Size: 23mm x 28mm
Bottom Head Diameter: 19mm
Stem Length: 14mm
Fits into 9mm Hole
Chevrolet Caprice & SS 2011 - On
Pontiac G8 2009 - 2008

UNIT PACKAGE: 15



20326

(25718851)
Yellow Nylon

Door Trim Moulding Clip
Head Size: 9/16" x 3/4"
Stem Length: 3/8"
Cadillac DeVille & Seville 1998 - On

UNIT PACKAGE: 25



22022

(GM: 24405740)
Blue Nylon

Windshield Pillar, Interior & Trunk Trim Moulding Clip with Metal Reinforcement
Top Head Size: 17mm x 20mm
Bottom Head Size: 14mm x 28mm
Stem Length: 11mm
Buick Allure, Lacrosse, Regal & Verano, Cadillac XTZ, Chevrolet Camaro, Caprice, Cruze, Malibu, Sonic & Volt, Pontiac G8 and Saturn Astra 2008 - On

UNIT PACKAGE: 15



22024

(GM: 24405739)
Black Nylon

Windshield Pillar & Interior Trim Moulding Clip with Metal Reinforcement
Top Head Size: 17mm x 20mm
Bottom Head Size: 14mm x 28mm
Stem Length: 12mm
Buick Allure, Encore, Lacrosse, Regal & Verano, Cadillac XTZ, Chevrolet Camaro, Caprice, Cruze, Malibu & Sonic 2010 - On

UNIT PACKAGE: 15



22080

(GM: 11611623)
Blue Nylon

Interior Trim & Windshield Pillar Moulding Clip with Metal Reinforcement
Top Head Size: 17mm x 24mm
Bottom Head Size: 14mm x 28mm
Stem Length: 10mm
Cadillac ATS & Escalade, Chevrolet Corvette, Impala & Malibu and GMC Sierra & Yukon 2013 - On

UNIT PACKAGE: 10



22167

(GM: 11547026)
Red Nylon

Interior Trim & Windshield Garnish Moulding Clip with Metal Reinforcement
Top Head Size: 17mm x 24mm
Bottom Head Size: 14mm x 28mm
Stem Length: 10mm
Cadillac ATS & CTS, Chevrolet Impala and GMC Yukon 2013 - On

UNIT PACKAGE: 10

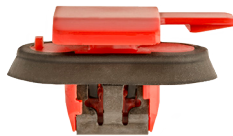

22276

(GM: 11547024)
Red Nylon

Door Sill Plate Moulding Clip with Metal Reinforcement & Sealer
Top Head Size: 17mm x 24mm
Bottom Head Size: 10mm x 24mm
Stem Length: 10mm
Cadillac ELR & XTS 2013 - On
Chevrolet Camaro & Malibu 2016 - On

UNIT PACKAGE: 10



22268

(GM: 11611367)
Blue Nylon

Scuff Plate & Trim Panel Moulding Clip with Sealer & Metal Reinforcement
Top Head Size: 17mm x 24mm
Bottom Head Size: 10mm x 24mm
Stem Length: 10mm
Overall Height: 16mm
Buick Verano, Cadillac ATS, CTS & XTS, Chevrolet Camaro, Impala, Malibu & Volt 2011 - On

UNIT PACKAGE: 10



19757

(10431524)
Black Nylon

Rocker Panel Moulding Clip
Head Size: 11/16" x 1-5/16"
Stem Length: 9/16"
Fits into 5/16" Hole
Chevrolet Impala, Lumina & Monte Carlo 2000 - On

UNIT PACKAGE: 15



19800

(10352803, 10437565)
Black Nylon

Rocker Panel Moulding Clip
Head Size: 15/32" x 1-5/16"
Stem Length: 9/16"
Fits into 5/16" Hole
Chevrolet Impala, Lumina & Monte Carlo 2000 - On

UNIT PACKAGE: 10



20810

(10431523)
Tan Nylon

Rocker Panel Moulding Clip
Head Size: 11/16" x 1-5/16"
Stem Length: 9/16"
Fits into 5/16" Hole
Chevrolet Impala, Lumina & Monte Carlo 2000 - On

UNIT PACKAGE: 15



20811
(10431526)
Red Nylon

Rocker Panel Moulding Clip
Head Size: 11/16" x 1-5/16"
Stem Length: 9/16"
Fits into 5/16" Hole
Chevrolet Impala, Lumina
& Monte Carlo 2000 - On

UNIT PACKAGE: 15



20974
(10352804)
Maroon Nylon

Rocker Panel Moulding Clip
Head Size: 15/32" x 1-9/32"
Stem Length: 11/16"
Fits into 5/16" Hole
Chevrolet Impala, Lumina
& Monte Carlo 2000 - On

UNIT PACKAGE: 10



20775
(10352809)
White Nylon

Rocker Panel Moulding Clip
Head Size: 11/16" x 1-5/16"
Stem Length: 11/16"
Fits into 5/16" Hole
Chevrolet Impala, Lumina &
Monte Carlo 2000 - On

UNIT PACKAGE: 15



20976
(25742293)
Blue Nylon

Rocker Panel Moulding Clip
Top Head Size: 9/16" x 25/32"
Bottom Head Size: 5/8" x 25/32"
Stem Length: 9/16"
Fits into 3/8" Hole
Cadillac DeVille & Seville 2000 - On

UNIT PACKAGE: 15



20809
(10352797)
Gray Nylon

Rocker Panel Moulding Clip
Head Size: 11/16" x 1-5/16"
Stem Length: 11/16"
Fits into 5/16" Hole
Chevrolet Impala, Lumina
& Monte Carlo 2000 - On

UNIT PACKAGE: 15



20972
(11589176)
White Nylon

Rocker Panel Moulding Clip
Top Head Size: 3/4" x 1-1/32"
Bottom Head Size: 19/32" x 1-1/32"
Stem Length: 9/16"
Fits into 3/8" Hole
Chevrolet Malibu 2004 - On

UNIT PACKAGE: 15



20808
(10352799)
Black Nylon

Rocker Panel Moulding Clip
Head Size: 11/16" x 1-5/16"
Stem Length: 11/16"
Fits into 5/16" Hole
Chevrolet Impala, Lumina
& Monte Carlo 2000 - On

UNIT PACKAGE: 15



20865
(15221959)
Gray Nylon

Rocker Panel Moulding Clip
Width: 9/16"
Length: 1-1/8"
Stem Length: 9/16"
Fits into 1/2" Hole
Chevrolet Cobalt & HHR 2005 - On

UNIT PACKAGE: 15



20973
(10352798)
Tan Nylon

Rocker Panel Moulding Clip
Head Size: 11/16" x 1-5/16"
Stem Length: 11/16"
Fits into 5/16" Hole
Chevrolet Impala, Lumina
& Monte Carlo 2000 - On

UNIT PACKAGE: 15



19820
(22603384)
White Nylon

Rocker Panel Moulding Clip
Head Size: 3/4" x 1-3/16"
Stem Length: 19/32"
Fits into 7/16" Hole
Oldsmobile Alero
& Pontiac Grand Am 1999 - On

UNIT PACKAGE: 15



21128
(11562563)
White Nylon

Rocker Moulding Clip
Upper Head Size: 12mm x 20mm
Bottom Head Size: 12mm x 32mm
Stem Length: 15mm
Fits into 10mm Hole
Chevrolet Malibu 2008 - On

UNIT PACKAGE: 15

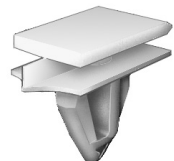

20607
(10323057)
White Nylon

Rocker Moulding Clip
Top Head Size: 12mm x 20mm
Bottom Head Size: 12mm x 24mm
Stem Length: 14mm
Fits into 9mm Hole
Pontiac Grand Prix 2004 - On

UNIT PACKAGE: 15



20952
(15236894)
White Nylon

Rocker Panel Moulding Clip
Top Head Size: 9/16" x 23/32"
Overall Height: 5/8"
Stem Length: 7/16"
Fits into 3/8" Hole
Buick Lucerne and
Cadillac CTS & STS 2003 - On

UNIT PACKAGE: 15



20377
(11518357)
White Nylon

Rocker Panel Moulding Clip with Sealer
Top Head Size: 9/16" x 13/16"
Bottom Head Size: 13/16" x 13/16"
Stem Length: 9/16"
Fits into 7/16" Hole
Chevrolet Avalanche 2002 - On

UNIT PACKAGE: 15



20417
(91176726)
White Nylon

Side Door, Wheel Opening &
Rocker Panel Moulding Clip with Sealer
Top Head Size: 15/32" x 25/32"
Bottom Head Size: 9/16" x 25/32"
Stem Length: 7/16"
Fits into 7/16" Hole
Geo Tracker 2001 - On

UNIT PACKAGE: 15



20328
(10443956)
White Nylon

Rocker Panel Moulding Clip
Top Head Size: 9/16" x 13/16"
Bottom Head Size: 13/16" x 13/16"
Stem Length: 9/16"
Fits into 7/16" Hole
Chevrolet Impala, Lumina, Monte Carlo
and C & K Trucks 2000 - On

UNIT PACKAGE: 15



19822
(25693852)
Gray Nylon

Rocker Panel Moulding Clip
Top Head: 9/16" x 3/4"
Bottom Head: 5/8" x 3/4"
Stem Length: 9/16"
Fits into 7/16" Hole
Buick LeSabre; Cadillac Concours,
DeVille, Eldorado & Seville; Chevrolet
Impala, Lumina & Monte Carlo;
Oldsmobile Aurora and
Pontiac Bonneville 1995 - On

UNIT PACKAGE: 25



20885
(15288146, 15893516)
Gray Nylon

Windshield Pillar
Moulding Clip with Sealer
Top Head Size: 12mm x 20mm
Bottom Head Size: 14mm x 20mm
Stem Length: 15mm
Fits into 9mm Hole
Chevrolet Equinox &
Pontiac Torrent 2005 - On

UNIT PACKAGE: 15



22258
(GM: 11547211)
White Nylon

Rocker Moulding Clip
with Sealer
Top Head Size: 12mm x 20mm
Bottom Head Size: 12mm x 20mm
Stem Length: 16mm
Fits into 9mm Hole
Cadillac CT6 2016 - On

UNIT PACKAGE: 10



21793
(GM: 11610495)
White Nylon

Rocker Panel
Moulding Clip with Sealer
Top Head Size: 12mm x 20mm
Bottom Head Size: 12mm x 24mm
Stem Length: 14mm
Fits into 9mm Hole
Chevrolet Camaro 2010 and
Pontiac G6 & Grand Prix 2004 - On

UNIT PACKAGE: 15



22036
(GM: 11546635, 11612122)
Yellow Nylon

Rocker Moulding Clip
with Sealer
Top Head Size: 9mm x 20mm
Bottom Head Size: 14mm x 20mm
Stem Length: 14mm
Fits into 9mm Hole
Cadillac ATS & CTS 2013 - On

UNIT PACKAGE: 10



20774
(25724529)
White Nylon

Rocker Moulding &
Grille Moulding Clip
Top Head Size: 9/16" x 13/16"
Bottom Head Size: 5/8" x 13/16"
Stem Length: 9/16"
Fits into 3/8" Hole
Buick LeSabre & Rainier; Cadillac
Concours, CTS, DeVille, Eldorado,
Escalade, Seville, SRX & STS; Chevrolet
Avalanche, Impala, Lumina, Monte Carlo,
SSR, Vans & Trucks; Oldsmobile Aurora &
Bravada and Pontiac Bonneville 1992 - On

UNIT PACKAGE: 15

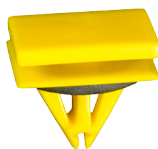

20756
(5480852)
Yellow Nylon

Rocker Panel
Moulding Clip with Sealer
Top Head Size: 9/16" x 25/32"
Bottom Head Size: 5/8" x 13/16"
Stem Length: 9/16"
Chevrolet Equinox 2005 - On

UNIT PACKAGE: 10



20934
(15127746)
White Nylon

Body Side Moulding Clip
Top Head Size: 12mm x 20mm
Bottom Head Size: 12mm x 20mm
Stem Length: 11mm
Fits into 9mm Hole
Buick Terraza, Chevrolet Uplander, GMC Acadia,
Pontiac Montana SV6 and Saturn Relay 2005 - On

UNIT PACKAGE: 15



21242
(11562250)
White Nylon

Rocker Panel Moulding Clip with Sealer
Top Head Size: 12mm x 20mm
Bottom Head Size: 12mm x 20mm
Stem Length: 11mm
Fits into 9mm Hole
GMC Acadia 2007 - On

UNIT PACKAGE: 15



21374
(GM: 11571175;
Chrysler: 68172491AA)
Gray Nylon

Rocker Moulding Clip with Sealer
Top Head Size: 12mm x 20mm
Bottom Head Size: 12mm x 20mm
Stem Length: 11mm
Fits into 9mm Hole
Chevrolet Traverse 2010 - On
Chrysler 200 2015 - On
Jeep Grand Cherokee 2015 - 2012

UNIT PACKAGE: 15



21156
(11570512)
Yellow Nylon

Side Window Reveal
Moulding Clip with Sealer
Width: 12.5mm
Length: 28mm
Overall Height: 13mm
Fits into 6mm Hole
Buick Lucerne 2006 - On

UNIT PACKAGE: 10



21129
(11569918)
White Nylon

Roof Rail Moulding Clip with Sealer
Top Head Size: 13mm x 30mm
Stem Length: 13mm
Fits into 7mm Hole
Buick Enclave &
GMC Acadia 2007 - On

UNIT PACKAGE: 15



20481
(10423553)
Green Nylon

Side Moulding, Fender &
Rocker Panel Moulding Clip
Top Head Size: 1/2" x 13/16"
Bottom Head Size: 19/32" x 13/16"
Stem Length: 9/16"
Fits into 7/16" Hole
Pontiac Aztek and
GM C & K Trucks 2001 - On

UNIT PACKAGE: 15



20521
(10242285, 10308019, 10297369)
Black Nylon with Sealer

Rocker Panel Moulding Clip
Top Head Size: 15/32" x 25/32"
Bottom Head Size: 5/8" x 25/32"
Stem Length: 9/16"
Fits into 7/16" Hole
Pontiac Aztek, Montana
& Trans Sport 1997 - On

UNIT PACKAGE: 15



20353
(10442914)
White Nylon

Rocker Panel Moulding Clip
Top Head Size: 1/2" x 9/16"
Bottom Head Size: 9/16" x 5/8"
Stem Length: 9/16"
Fits into 7/16" Hole
Buick Rendezvous 2002 - On

UNIT PACKAGE: 15



21504
(GM: 10445899)
Black Nylon

Door Moulding Clip
Top Head Size: 14mm x 20mm
Bottom Head Size: 15.5mm x 20mm
Stem Length: 14mm
Fits into 9mm Hole
GM SUV's 1997 - On

UNIT PACKAGE: 15



22027
(GM: 11570847)
Yellow Nylon

Lower Door Moulding Clip with Sealer
Top Head Size: 12.5mm x 20mm
Bottom Head Diameter: 18mm
Stem Length: 11mm
Fits into 9mm Hole
Cadillac SRX 2010 - On

UNIT PACKAGE: 10



19381
(10297368)
White Nylon

Rear Wheel Opening Moulding Clip
Top Head Size: 15/32" x 25/32"
Bottom Head Size: 1/2" x 25/32"
Stem Length: 9/16"
Fits into 7/16" Hole
Pontiac Trans Sport, Montana
with Short Wheel Base 1997 - On

UNIT PACKAGE: 10



19379
(10297371)
Yellow Nylon

Rear Wheel Opening Moulding Clip
Top Head Size: 19/32" x 25/32"
Stem Length: 9/16"
Fits into 7/16" Hole
Pontiac Trans Sport, Montana
with Long Wheel Base 1997 - On

UNIT PACKAGE: 15



20825
(10297370)
Brown Nylon

Moulding Clip with Sealer
Top Head Size: 12mm x 20mm
Bottom Head Size: 15mm x 20mm
Stem Length: 14mm
Fits into 11mm Hole
Chevrolet Venture, Oldsmobile Silhouette, Pontiac
Trans Sport APV & Montana and Hummer 1997 - On

UNIT PACKAGE: 15



22029
(GM: 11547210)
Green Nylon

Moulding Clip with Sealer
Top Head Size: 12mm x 20mm
Bottom Head Size: 12mm x 20mm
Stem Length: 10mm
Fits into 9mm Hole
Cadillac XTS & Chevrolet Impala 2014 - 2013

UNIT PACKAGE: 10

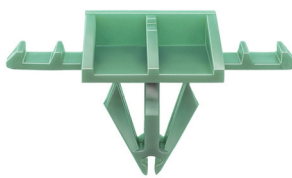

20935
(15116576, 15282120)
Green Nylon

Body Side Moulding Clip
Head Size: 16mm x 38mm
Stem Length: 15mm
Fits into 10mm Hole
Buick Terraza, Cadillac C & K Truck, Chevrolet C, K
Truck & Uplander, GMC Arcadia, C & K Truck, Pontiac
Montana SV6 and Saturn Relay 2005 - On

UNIT PACKAGE: 15



21036
(11518988)
White Nylon

Fender, Spoiler & Roof Rack
Moulding Clip with Sealer
Top Head: 12mm x 21mm
Bottom Head: 12mm x 20mm
Stem Length: 15mm
Fits into 9mm Hole

Buick Enclave, Chevrolet SSR,
GMC Acadia, Hummer H3, S & T Trucks 2002 - On

UNIT PACKAGE: 15



21667
(11609923)
Gray Nylon

Moulding Clip with Sealer
Top Head Size: 12mm x 20mm
Bottom Head Size: 12mm x 24mm
Stem Length: 16mm

Chevrolet Camaro and Pontiac G6 2005 - On

UNIT PACKAGE: 15



21681
(GM: 25796285)
White Nylon

Moulding Clip with Sealer
Top Head Size: 6.5mm x 15mm
Bottom Head Size: 13mm x 26mm
Stem Length: 8mm
Fits into 7mm Hole

Cadillac CTS & Chevrolet Silverado
2007 - On

UNIT PACKAGE: 15



21013
(Not Available from O.E.M.)
Yellow Nylon

Rocker Panel Moulding Clip
Top Head Size: 15/32" x 13/16"
Bottom Head Size: 15/32" x 25/32"
Stem Length: 9/16"
Fits into 3/8" Hole

Hummer H3 2005 - On

UNIT PACKAGE: 15



21370
(GM: 25922739, 11570846)
Green Nylon

Rocker Moulding Clip with Sealer
Top Head Size: 12mm x 29mm
Bottom Head Size: 12mm x 20mm
Stem Length: 10mm
Fits into 9mm Hole

Buick Enclave, Cadillac SRX, Chevrolet Tahoe,
Traverse & GMC Acadia, Yukon 2009 - On

UNIT PACKAGE: 25



21200
(11588818, 11561329)
Black Nylon

Front Bumper and
Rocker Moulding Clip
Top Head Size: 18mm x 26mm
Bottom Head Size: 14mm x 20mm
Stem Length: 15mm
Fits into 10mm Hole

Cadillac STS and Corvette 2005 - On

UNIT PACKAGE: 10



22225
(GM: 92138808)
Black Nylon

Rocker Moulding Clip
Top Head Size: 15mm x 21mm
Middle Head Size: 15mm x 21mm
Bottom Head Size: 19.3mm x 25.5mm
Stem Length: 14mm
Fits into 9mm Hole

Chevrolet Caprice & SS 2011 - On
Pontiac G8 2009 - 2008

UNIT PACKAGE: 25



20951
(15236893)
Black Nylon

Rocker Panel
Moulding Clip
Top Head Size: 3/4" x 1-9/16"
Overall Height: 11/16"
Stem Length: 7/16"
Fits into 3/8" Hole

Buick Lucerne 2006 - On

UNIT PACKAGE: 15



20868
(11589182)
Black Nylon

Rocker Panel Moulding
Clip with Sealer
Head Size: 11/16" x 2-3/16"
Stem Length: 11/16"
Fits into 5/8" Hole

Hummer 2006 - On

UNIT PACKAGE: 10



20884
(11561491, 15872008)
Black Nylon

Rocker Panel Moulding Clip
with Sealer
Top Head: 20mm x 30mm
Overall Length: 28mm
Fits into 17mm Hole

Chevrolet Equinox & Pontiac Torrent 2005 - On

UNIT PACKAGE: 10



21503
(GM: 25744385)
Green Nylon

Rocker Moulding Clip
Head Size: 22mm x 46mm
Stem Length: 17mm
Fits into 10mm Hole
Cadillac 1998 - On

UNIT PACKAGE: 15



22226
(GM: 92138807)
White Nylon

Rocker Moulding Clip
Width: 31.5mm
Length: 45mm
Bottom Head Diameter: 25mm
Stem Length: 15mm
Fits into 9mm Hole
Chevrolet Caprice & SS 2011 - On
Pontiac G8 2009 - 2008

UNIT PACKAGE: 25



21177
(10363352)
Black Nylon

Rocker, Pillar and
Floor Moulding Clip
Top Head Size: 18mm x 38mm
Bottom Head Size: 22mm x 40mm
Stem Length: 33mm
Fits into 11mm Hole
Saturn Aura 2007 - On

UNIT PACKAGE: 15

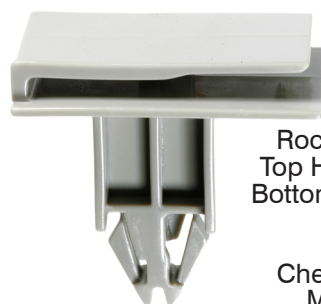

19821
(10431761)
Gray Nylon

Rocker Panel Moulding Clip
Top Head Size: 11/16" x 1-1/2"
Bottom Head Size: 7/8 x 1-9/16"
Stem Length: 1-1/4"
Fits into 7/16" Hole
Chevrolet Impala, Lumina &
Monte Carlo 2000 - On

UNIT PACKAGE: 15

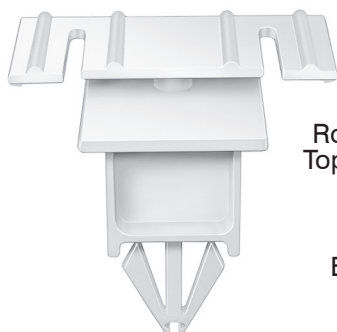

20950
(10384814)
White Nylon

Rocker Panel Moulding Clip
Top Head Size: 3/4" x 1-9/16"
Overall Height: 1-7/16"
Stem Length: 21/32"
Fits into 7/16" Hole
Buick Lucerne 2006 - On

UNIT PACKAGE: 15



20464
(10270517)
White Nylon

Rocker Panel & Fender Flare
Moulding Clip
Overall Length: 41mm
Stem Length: 13mm
Fits into 12mm Hole
Pontiac Trans Sport & Montana 1997 - On

UNIT PACKAGE: 5



21827
(GM: 11611435)
White Nylon

Moulding Clip
with Sealer
Top Head Size: 22mm x 45mm
Bottom Head Size: 25mm x 37mm
Stem Length: 15mm
Fits into 10mm Hole
Cadillac, Chevrolet & GMC 2014 - 13

UNIT PACKAGE: 10



21161
(GM: 11569697)
Green Nylon

Side Window (Rear) Reveal
Moulding Clip with Sealer
Flange Size: 10mm x 17mm
Stem Length: 20mm
Overall Length: 29mm
Fits into 8mm Hole
Buick Lucerne 2006 - On

UNIT PACKAGE: 5



21157
(11610522, 10383817)
White Nylon

Side Window (Rear) Reveal
Moulding Clip with Sealer
Top Head Size: 6mm x 11mm
Bottom Head Size: 10mm x 17mm
Stem Length: 20mm
Fits into 8mm
Buick Lucerne 2006 - On

UNIT PACKAGE: 10



22037
(GM: 15864780; 11569921)
Yellow Nylon

Rocker Moulding Clip with Sealer
Top Head Size: 9.5mm x 20mm
Bottom Head Size: 14mm x 20mm
Stem Length: 20mm
Fits into 9mm Hole
Cadillac ATS & CTS 2013 - On

UNIT PACKAGE: 10



21335
(25775903)
Green Nylon

Rocker Moulding Clip with Sealer
Top Head Size: 12mm x 16mm
Bottom Head Size: 12mm x 20mm
Stem Length: 24mm
Fits into 9mm Hole
Buick Enclave, Chevrolet Traverse,
GMC Acadia & Saturn Outlook 2007 - On

UNIT PACKAGE: 10



21375
(25774893)
Yellow Nylon

Door Moulding Clip
Top Head Size: 12mm x 16mm
Bottom Head Size: 12mm x 20mm
Stem Length: 24mm
Fits into 9mm Hole
Chevrolet Traverse 2010 - On

UNIT PACKAGE: 15



20891
(11589244, 11569973)
Yellow Nylon

Rocker Panel
Moulding Clip with Sealer
Top Head Size: 15/32" x 27/32"
Bottom Head Size: 15/32" x 25/32"
Stem Length: 1-3/8"
Fits into 7/16" Hole
Chevrolet Equinox, Pontiac Torrent
and Trucks 2005 - On

UNIT PACKAGE: 10



21739
(GM: 11611626)
White Nylon

Tailgate Cover Clip
Top Head Size: 12.5mm x 23mm
Bottom Head Size: 12.5mm x 23mm
Stem Length: 11mm
Fits into 9mm Hole
Cadillac Escalade; Chevrolet Avalanche,
Silverado, Suburban & Tahoe and GMC
Sierra 2007 - On

UNIT PACKAGE: 25



11118
(9617200)
Nylon

Roof, Inner Side Front, Rear &
Panel Headlining Clip
GM 1973-On

UNIT PACKAGE: 10

11119

Same as 11118 except for unit package quantity

UNIT PACKAGE: 100



18398
(20058837)
Nylon

Windshield Upper Garnish
Moulding Clip
GM A & G Models 1988-78

UNIT PACKAGE: 10



17666
(20632190)
Nylon

Garnish Moulding Clip
Back Window Upper &
Side Moulding Garnish
Buick LeSabre, Cadillac
Fleetwood Brougham,
Chevrolet Caprice & Impala,
Olds Delta 88 & 98, Pontiac
Bonneville & Parisienne 1989-80

UNIT PACKAGE: 10



16865
(20462090)
Nylon

Garnish Moulding Clip
Buick Century & Regal, Chevrolet
Camaro, Celebrity, Monte Carlo &
Malibu, Oldsmobile Cutlass & Ciera,
Pontiac Firebird Grand Prix & 6000
1978-On

UNIT PACKAGE: 25



9477
(4490167)
Nylon

Tailgate Belt
Moulding Fastener
Chevrolet El Camino

UNIT PACKAGE: 50



17233
(9662548)
Nylon

Headlining Wire Retainer Clip
Also Panel to Rear Bumper Filler Clip
GM 1990 - 73

UNIT PACKAGE: 50



9965
(3944866, 1244839)

Universal Moulding Fastener
GM

UNIT PACKAGE: 25

12971

Same as 9965 except for unit package quantity

UNIT PACKAGE: 10



2943
(4759145, 4761842, 4779348)

Front and Rear Fender and
Door Peak Moulding Fastener
GM

UNIT PACKAGE: 15

12966

Same as 2943 except for unit package quantity

UNIT PACKAGE: 15



19602

Chevrolet Grille Bolt Kit
For installing and attaching Grille on Chevrolet Cars
Consists of: 50 pcs. 10-24 x 1/2" Machine Screws
50 pcs. 10-24 Keps Nuts

UNIT PACKAGE: 50 Sets



14953
(GM: 15679091; Ford: N803494S)
Black Nylon

Fascia, Trim & Grille Retainer
Head Size: 15/32" x 15/32"
Stem Length: 21/32"
Fits into 1/4" Square Hole or Slot
GM 1994 - On
Ford 1985 - On

UNIT PACKAGE: 25



14727

(GM: 94221150;
Isuzu: 8942211500;
Nissan: 63844-D0100)
Black Nylon

Push-Type Retainer
Head Size: 14mm x 22mm
Stem Length: 9mm
Fits into 7mm Hole
Geo Storm 1990 - On

UNIT PACKAGE: 25



20892

(12337831)
Black Nylon

Front Bumper
Push-Type Retainer
Head Size: 14mm x 26mm
Stem Length: 14mm
Fits into 8mm Hole
Pontiac G6 2005 - On

UNIT PACKAGE: 50



14008

(14032200)
Black Nylon

Grille Attachment Retainer
Head Size: 3/4" x 19/32"
Stem Length: 19/32"
Fits into 5/16" Hole
GM 1981-On

UNIT PACKAGE: 25



22041

(GM: 92139147)
Black Nylon

Front & Rear Bumper Fascia
Push-Type Retainer
Head Size: 14mm x 21mm
Stem Length: 16mm
Fits into 8mm Hole
Chevrolet Caprice and
Pontiac G8 & GTO 2011 - 04

UNIT PACKAGE: 25



14001

(14039420)
Black Nylon

Push-Type Retainer
Head Diameter: 21/32"
Stem Length: 19/32"
Fits into 5/16" Hole
GM (Including Saturn)

UNIT PACKAGE: 25



14697

(GM: 94198687;
Honda: 90657-SA6-0030;
Mazda: N304-13-356-A)
Black Nylon

Push-Type Retainer
Head Diameter: 14mm
Stem Length: 11mm
Fits into 7mm Hole

UNIT PACKAGE: 25



19726

(94858343)
Black Nylon

Door Trim Panel Push-Type Retainer
Head Diameter: 14mm
Stem Length: 8mm (Excluding the Pin)
Fits into 6mm Hole
Geo Prizm 1998 - On

UNIT PACKAGE: 15



19645

(94858864)
Nylon

Door Trim Panel
Push-Type Retainer
Head Diameter: 14mm
Stem Length: 8mm (Excluding the Pin)
Fits into 6mm Hole
Geo Prizm 1998 - On

UNIT PACKAGE: 15



14260

(Toyota: 90467-06017;
Mazda: 9926-50-625;
GM: 20426301)
Black Nylon

Push-Type Retainer
Head Diameter: 15mm
Stem Length: 12mm
Fits into 7mm Hole

UNIT PACKAGE: 15



19243

(GM: 30008324; Suzuki: 09409-07325)
Black Nylon

Push-Type Retainer
Head Diameter: 16mm
Stem Length: 10mm (Excluding the Pin)
Fits into 9mm Hole
Front & Rear Bumper Fascia
Geo Metro 1989-On
Radiator Grille
Suzuki Esteem 1995-On

UNIT PACKAGE: 15



13457

(20451119)
Black Nylon

Front Compartment Spare Tire Retainer
Head Diameter: 43/64"
Stem Length: 23/32"
Fits into 5/16" Hole
GM

UNIT PACKAGE: 10



20577

(GM: 88970494, 88973676;
Toyota: 90467-07168)
Black Nylon

Rocker Panel & Garnish
Moulding Push-Type Retainer
Head Diameter: 20mm
Stem Length: 8mm
Fits into 7mm Hole
Pontiac Vibe 2003 - On
Lexus & Toyota 2000 - On

UNIT PACKAGE: 15



19140

(Acura: 90505-SL0-003;
GM: 94852368;
Mitsubishi: MB888869;
Toyota: 90467-08155)
Black Nylon

Push-Type Retainer
Head Diameter: 20mm
Stem Length: 21mm
Fits into 8mm Hole

Acura, Dodge Avenger, Eagle Talon, Geo Prizm
Mitsubishi Eclipse & Galant and Toyota 1993-On

UNIT PACKAGE: 5



19242

(15672149)
Black Nylon

Air Inlet Grille Panel Push-Type Retainer
Head Diameter: 13/32"
Stem Length: 11/16"
Fits into 7/32" Hole
GM Jimmy, Blazer, S-10 & Bravada 1994-On

UNIT PACKAGE: 25



17214

(GM: 10089262, 21042098;
Chry: 55075139)
Black Nylon

Push-Type Retainer
Head Diameter: 11mm (7/16")
Stem Length: 18mm (11/16")
Fits into 6mm (15/64") Hole

GM & Saturn 4 Door & Station Wagon 1987-On

UNIT PACKAGE: 25

14987

Same as 17214 except for unit package quantity

UNIT PACKAGE: 50



14990

(22538102)
Black Nylon

Push-Type Retainer
Head Diameter: 7/16"
Stem Length: 15/32"
Fits into 15/64" Hole
GM 1987 - On

UNIT PACKAGE: 50



19788

(10246149; 22657634)
Black Nylon

Rocker Panel Push-Type Retainer
Head Diameter: 11mm
Stem Length: 20mm
Fits into 6mm Hole

Achieva, Cutlass, Grand Am & Malibu 1999 - On

UNIT PACKAGE: 25



19787

(22657634)
Black Nylon

Fender & Rocker Panel
Push-Type Retainer
Head Diameter: 12mm
Stem Length: 17mm
Fits into 6mm Hole

Achieva, Cutlass, Grand Am & Malibu 1999 - On

UNIT PACKAGE: 25



14995

(GM: 10195515, Ford: N805026S;
Chry: 4696488, 6503163)
Black Nylon

Push-Type Retainer
Head Diameter: 1/2"
Stem Length: 1-13/64"
Fits into 9/32" Hole

GM, Ford & Chrysler 1987 - On

UNIT PACKAGE: 25



16859

(Nissan: 66860-01W01;
GM: 94051993)
Black Nylon

Cowl Panel to Reinforcement
Plate & Engine Splash
Shield Retainer

Head Diameter: 14mm (9/16")
Stem Length: 16mm (5/8")
Fits into 6mm (1/4") Hole

Nissan 1980-On
Geo Storm 1990-On

UNIT PACKAGE: 25



20943

(15014352)
Black Nylon

Cowl Vent
Push-Type Retainer
Head Diameter: 14mm
Stem Length: 23mm
Fits into 7mm Hole
Buick Lucerne 2006 - On

UNIT PACKAGE: 15



21112

(94530438)
Black Nylon

Fender Liner
Push-Type Retainer
Head Diameter: 15mm
Stem Length: 14mm
Fits into 6mm Hole
Chevrolet Aveo 2004 - On

UNIT PACKAGE: 25



14997

(10053182)
Black Nylon

Push-Type Retainer
Head Diameter: 19/32"
Stem Length: 13/16"
Fits into 5/16" Hole
GM 1987 - On

UNIT PACKAGE: 25



14991
(GM: 10139822; 25680782;
Ford: N808147S)
Black Nylon

Push-Type Retainer
Head Diameter: 11/16"
Stem Length: 11/16"
Fits into 1/4" Hole
GM & Ford 1987 - On

UNIT PACKAGE: 25



20265
(25663903)
Black Nylon

Radiator Support Sight Shield
Push-Type Retainer
Head Diameter: 1"
Stem Length: 1"
Fits into 1/4" Hole
Cadillac DeVille & Seville 1998 - On

UNIT PACKAGE: 10



14753
(GM: 15773445, 20452072, 20664092;
Ford: N804570S; Chry: 4638136)
Black Nylon

Radiator Shroud & Trim Retainer
Head Diameter: 11/16"
Stem Length: 7/8"
Fits into 1/4" Hole
GM 1982-On
Ford 1986-On
Chrysler 1998 - On

UNIT PACKAGE: 25



17227
(21077405)
Black Nylon

Door Handle to Door Hardware
Attachment Push-Type Retainer
Head Diameter: 7mm
Stem Length: 10mm
Fits into 5mm Hole
2 Door & 4 Door Models GM Saturn 1991-On

UNIT PACKAGE: 25



14993
(22538004)
Black Nylon

Push-Type Retainer
Head Diameter: 11/16"
Stem Length: 7/8"
Fits into 1/4" Hole
GM 1987 - On

UNIT PACKAGE: 25



17383
(GM: 94847334, 96057847;
Toyota: 90467-07066;
Suzuki: 09409-07313)
Black Nylon

Radiator Grille & Trim Panel
Push-Type Retainer
Head Diameter: 11mm
Stem Length: 14mm (Excluding the Pin)
Fits into 7mm Hole
Geo Tracker & Prizm 1992 - 89

UNIT PACKAGE: 10



16835
(GM: 10140480; Chry: 6502625)
Black Nylon

Rear Bumper Fascia Retainer
Head Diameter: 21mm (27/32")
Shoulder Length: 3mm (1/8")
Stem Length: 25mm (1")
Fits into 12mm (1/2") Hole
APV Vans 1990-On

UNIT PACKAGE: 25



11854
(14005089)
Natural Nylon

Air Conditioning Vent &
General Purpose Push-Type Retainer
Head Diameter: 7/16"
Stem Length: 9/32"
Fits into 3/16" Hole
GM 1979 - On

UNIT PACKAGE: 25



14998
(15672330, 15956470)
Black Nylon

Push-Type Retainer
Head Diameter: 27/32"
Stem Length: 1"
Fits into 13/32" Hole
GM 1987 - On

UNIT PACKAGE: 25



21246
(22690838)
Black Nylon

Door Trim Push-Type Retainer
Head Diameter: 12mm
Stem Length: 14mm (Excluding the Pin)
Fits into 6mm Hole
Chevrolet Malibu & Pontiac G6 2004 - On

UNIT PACKAGE: 25



20666
 (22677979, 22677980)
 Gray Nylon
 Door Trim Push-Type Retainer
 Head Diameter: 12mm
 Stem Length: 14mm (Excluding the Pin)
 Fits into 6mm Hole
 Chevrolet Malibu 2004 - On
 UNIT PACKAGE: 25



17162
 (GM: 96057846; Hyundai: 86155-22000;
 Toyota: 90467-07041)
 Black Nylon
 Push-Type Retainer
 Head Diameter: 15mm
 Stem Length: 8mm (Excluding the Pin)
 Fits into 6.3mm Hole
 Geo Metro & Tracker 1989 - On
 UNIT PACKAGE: 10



19297
 (11517824, 21035345)
 Black Nylon
 Liftgate Upper Window & Lower Garnish
 Moulding Push-Type Retainer
 Head Diameter: 16mm
 Stem Length: 12mm (Excluding the Pin)
 Fits into 7mm Hole
 GM Saturn 1998 - 93
 UNIT PACKAGE: 15



11699
 (GM: 472434; Chry: 6031390)
 Black Nylon
 Cowl Ledge Weatherstrip &
 Fender Liner Push-Type Retainer
 Head Diameter: 11/16"
 Stem Length: 5/8"
 Fits into 1/4" Hole
 GM 1970-On
 Chrysler 1968-On
 UNIT PACKAGE: 50



19892
 (25695687)
 Black Nylon
 Radiator Support Sight Shield
 Push-Type Retainer
 Head Diameter: 27mm
 Shoulder Length: 7mm
 Stem Length: 18mm
 Fits into 10mm Hole
 Cadillac DeVille & Seville 2000 - On
 UNIT PACKAGE: 15



14011
 (14019226, 14071289)
 Black Nylon
 Radiator Overflow Bottle/Windshield
 Washer Bottle Retainer
 Head Diameter: 21/32"
 Stem Length: 9/16"
 Fits into 5/16" Hole
 GM 1981 - On
 UNIT PACKAGE: 25



12567
 (GM: 14019205, 14019206, 16514113;
 Chry: 34201621, 6504090)
 Black Nylon
 Front Fender Mud Skirt &
 Fender Liner Push-Type Retainer
 Head Diameter: 11/16"
 Stem Length: 9/16"
 Fits into 1/4" Hole
 GM 1981 - On
 UNIT PACKAGE: 25

14007
 Same as 12567 except for unit package quantity
 UNIT PACKAGE: 50



21238
 (22718369)
 Black Nylon
 Fuel Tank Shield &
 Miscellaneous Push-Type Retainer
 Head Diameter: 26mm
 Stem Length: 12mm
 Fits into 10mm Hole
 Chevrolet Malibu & Trail Blazer 2004 - On
 UNIT PACKAGE: 25



19847
 (5973823)
 Blue Nylon
 Fascia Retainer
 Head Diameter: 7/8"
 Shoulder Length: 5/32"
 Stem Length: 25/32"
 Fits into 1/2" Hole
 GM 1979-On
 UNIT PACKAGE: 25



14010
 (GM: 14045480; Chry: 6508746-AA)
 Black Nylon
 Fascia Retainer
 Head Diameter: 1"
 Stem Length: 23/32"
 Fits into 3/8" Hole
 GM 1982 - On and Chrysler 2009 - On
 UNIT PACKAGE: 25



12757
(5973400)
Black Nylon

Fascia Retainer
Head Diameter: 1"
Shoulder Length: 1/8"
Stem Length: 3/4"
Fits into 1/2" Hole
GM 1979 - On

UNIT PACKAGE: 15

16265

Same as 12757 except for unit package quantity

UNIT PACKAGE: 50



12756
(5973996)
Brown Nylon

Fascia Retainer
Head Diameter: 1"
Shoulder Length: 1/4"
Stem Length: 7/8"
Fits into 1/2" Hole
GM 1982 - On

UNIT PACKAGE: 15



19854
(21097229)
Black Nylon

Door Handle Push-Type Retainer
Head Diameter: 7mm
Stem Length: 10mm
Fits into 5mm Hole
Saturn 2 Door & 4 Door 1999 - On

UNIT PACKAGE: 25



14016
(GM: 16500308; Chry: 6500787)
Black Nylon

Tail Light Retainer
Top Head Diameter: 3/8"
Stem Length: 7/16"
Fits into 3/16" Hole
GM & Chrysler

UNIT PACKAGE: 25



13999
(20363491)
Black Nylon

Body Side Moulding Push-Type Retainer
Top Head Diameter: 3/8"
Stem Length: 1/2"
Fits into 7/32" Hole
GM 1979 - On

UNIT PACKAGE: 25



19522
(22644361)
Black Nylon

Door Sill Trim Plate
Push-Type Retainer
Head Diameter: 12mm
Stem Length: 18mm
Fits into 6mm Square Hole
Chev. Malibu, Olds Achieva & Cutlass 1997 - On

UNIT PACKAGE: 15



17106
(GM: 22566221; Chry: 6501577)
Black Nylon

Headlight Door Push-Type Retainer
Top Head Diameter: 1/2"
Stem Length: 7/16"
Fits into 3/16" Hole
GM Blazer & Suburban 1991 - On
Chrysler New Yorker Landau & 5th Avenue 1988 - On

UNIT PACKAGE: 50



19355
(15960621)
Black Nylon

Rear Door Radio Speaker
Push-Type Retainer
Head Diameter: 17/32"
Stem Length: 1-5/64"
Fits into 1/4" Hole
GM Trucks C & K 1, 2 1995 - On

UNIT PACKAGE: 25



16816
(21047094)
Black Nylon

Push-Type Retainer
Top Head Diameter: 14mm
Stem Length: 14mm
Fits into 6mm Hole
GM Saturn 1991 - On

UNIT PACKAGE: 25



17222
(GM: 21075686;
Ford: F3LY-14570-B)
Black Nylon

Push-Type Retainer
Head Diameter: 15mm
Stem Length: 20mm
Fits into 8mm Hole
Rocker Panel, Wheel Liner & Air Inlet Duct Applications
GM Saturn 2 Door & 4 Door Models 1991-On
Ford

UNIT PACKAGE: 25



22347
(GM: 11561878)
Black Nylon

Bumper, Fender Liner, Cowl, Grille,
Air Inlet Duct, Rocker Panel, Wheel Liner,
Quarter Panel & Upper Deflector
Push-Type Retainer with Sealer
Head Diameter: 15mm
Stem Length: 21mm
Fits into 8mm Hole
Various Buick, Cadillac Chevrolet,
GMC, Hummer, Saab &
Saturn Models 1991 - On

UNIT PACKAGE: 25



17103
(GM: 15681408;
Ford: N803709S)
Black Nylon

Fascia Retainer
Head Diameter: 15mm
Stem Length: 23mm
Fits into 6mm Hole
GM & Ford 1986 - On

UNIT PACKAGE: 50



17226
(10207146, 21077323)
Black Nylon

Rear Door Rocker Panel to Underbody
Bracket Push-Type Retainer
Head Diameter: 15mm
Stem Length: 29mm
Fits into 8mm Hole
GM Saturn 4 Door Models 1991 - On

UNIT PACKAGE: 25



19801
(GM: 21077123; Chry: 6509103AA
Ford: W705436-S300)
Black Nylon

Wheel Opening Moulding
Push-Type Retainer
Head Diameter: 19/32" (15mm)
Stem Length: 3/4" (19mm)
Fits into 1/4" (6mm) Hole
Saturn 1991 - On
Ford 2002 - On
Chrysler 2010 - On

UNIT PACKAGE: 25



20542
(15994165)
Black Nylon

Bumper & Rear Wheel Apron
Push-Type Retainer
Head Diameter: 16.5mm
Stem Length: 27mm
Fits into 8mm Hole
Saturn L Series 2000 - On

UNIT PACKAGE: 25



19639
(GM: 15149708; Chry: 6506008AA)
Black Nylon

Radiator, Wheelhouse, Fender & Front
Bumper Cover Push-Type Retainer
Head Diameter: 17mm
Stem Length: 16mm
Fits into 6mm Hole
GM C & K Trucks 1999 - On
Jeep Liberty 2002 - On

UNIT PACKAGE: 25



16624
(1636632, 20687704)
Black Nylon

Front Bumper Fascia Retainer
Head Diameter: 17mm
Shoulder Length: 2mm
Stem Length: 18mm
Fits into 9.5mm (3/8") Hole
Buick Riviera/Reatta 1988 - On

UNIT PACKAGE: 25



18030
(Chry: 6501925; GM: 10134407)
Black Nylon

Push-Type Retainer
Head Size: 11/16"
Stem Length: 13/16"
Fits into 1/4" Hole
Chrysler Concorde & LHS
Dodge Intrepid & Eagle Vision 1993-On
Coolant Recovery Reservoir
GM 1992-On

UNIT PACKAGE: 25



13993
(GM: 20510029; Ford: N803362-S;
Chry: 34202672)
Black Nylon

Body Retainer
Head Diameter: 11/16"
Stem Length: 7/8"
Fits into 1/4" Hole
Ford, GM & Chrysler 1984 - On

UNIT PACKAGE: 25



13996

(20452072, 20590899)
Black Nylon

Exterior Body Retainer
Head Diameter: 11/16"
Stem Length: 7/8"
Fits into 9/32" Hole
GM 1984-On

UNIT PACKAGE: 25



20869

(GM: 88970767;
Toyota: 90467-10183)
Black Nylon

Front Fender Liner
Push-Type Retainer
Head Diameter: 18mm
Stem Length: 7.5mm Hole
Fits into 7mm Hole

Pontiac Vibe, Lexus and Toyota 1999 - On

UNIT PACKAGE: 10



20365

(10301966, 10425306)
Black Nylon

Cowl Vent Push-Type Retainer
Head Diameter: 18mm
Stem Length: 13mm
Fits into 7.5mm Square Hole
Pontiac Aztek 2001 - On

UNIT PACKAGE: 10



20988

(GM: 11589289; Chrysler: 6508863-AA)
Black Nylon

Air Distributor & Windshield Defroster
Push-Type Retainer
Head Diameter: 18mm
Stem Length: 17.5mm
Panel Range: 2.0mm - 4.5mm
Fits into 6.5mm Hole
Buick Enclave, Chevrolet Equinox,
Chevrolet & GMC S & T Trucks, GMC
Acadia and Pontiac Torrent 2002 - On

UNIT PACKAGE: 25



20888

(GM: 11561368; Chry: 6508712AA)
Black Nylon

Fender, Wheel & Bumper
Push-Type Retainer
Head Diameter: 18mm
Stem Length: 20mm
Panel Range: 3.0mm - 5.8mm
Fits into 9.5mm Hole
Chevrolet Impala & Monte Carlo and
Pontiac Grand Prix & Solstice 2004 - On
Jeep Wrangler 2000 - On

UNIT PACKAGE: 25



20880

(GM: 11589290
Chry: 6509049-AA;
Ford: W714040-S300)
Black Nylon

Air Inlet Grille, Bumper Fascia &
Front Brake Caliper Cooling Duct
Push-Type Retainer
Head Diameter: 18mm
Stem Length: 20mm
Panel Range: 4.5mm - 7.0mm
Fits into 6.5mm Hole
Buick Enclave, Cadillac CTS & STS,
Chevrolet Cobalt, Equinox & SSR, GM
Trucks and Pontiac G5 & Torrent 2002 - On
Chrysler Charger & 300 2011 - On

UNIT PACKAGE: 50



21672

(11611110)
Black Nylon

Cowl Vent Push-Type
Retainer with Sealer
Head Diameter: 18mm
Stem Length: 20mm
Fits into 6.3mm Hole
Buick Allure & LaCrosse
and Chevrolet Volt 2010 - On

UNIT PACKAGE: 15



20989

(GM: 11589291;
Ford: W713331-S300)
Black Nylon

Air Dam & Grille Push-Type Retainer
Head Diameter: 18mm
Stem Length: 22mm
Panel Range: 7.0mm - 9.5mm
Fits into 6.5mm Hole
Cadillac CTS, SRX and STS 2003 - On

UNIT PACKAGE: 25



21529

(95230842)
Black Nylon

Cowl Vent Push-Type
Retainer with Sealer
Head Diameter: 18mm
Stem Length: 22mm
Fits into 6.5mm Hole
Chevrolet Cruze 2011 - On

UNIT PACKAGE: 15



22219
(GM: 92138636)
Black Nylon

Air Baffle Push-Type Retainer
Head Diameter: 18mm
Stem Length: 23mm
Fits into 7.5mm Hole
Chevrolet Caprice 2013 - 2012
Pontiac G8 and GTO 2009 - 2004

UNIT PACKAGE: 25



16622
(10157900, 11517803, 15993201)
Black Nylon

Front Bumper Fascia Retainer
Head Diameter: 18mm
Stem Length: 23mm
Fits into 9.5mm (3/8") Hole
Olds Cutlass 1990-On
GM Lt. Truck 1996 - On

UNIT PACKAGE: 25



20359
(11519444)
Black Nylon

Bumper Cover Push-Type Retainer
Head Diameter: 18mm
Stem Length: 26mm
Fits into 10mm Hole
Oldsmobile Intrigue, Pontiac
Aztek & Grand Prix 1997 - On

UNIT PACKAGE: 25



20631
(11588988)
Black Nylon

Front Bumper Cover Push-Type Retainer
Head Diameter: 18mm
Stem Length: 26mm
Fits into 10mm Hole
Pontiac Grand Prix 2004 - On

UNIT PACKAGE: 25



20826
(11609417)
Black Nylon

Fender Apron Push-Type Retainer
Head Diameter: 19mm
Stem Length: 14mm
Panel Range: 2.7mm - 5.3mm
Fits into 8.5mm Hole
Buick Enclave & LaCrosse, Cadillac CTS, SRX & STS,
Chevrolet Cobalt, Equinox & Malibu, GM Trucks and
Pontiac G5, G6 & Torrent 2003 - On

UNIT PACKAGE: 50



20990
(GM: 15296830;
Chrysler: 5116530-AA)
Black Nylon

Fascia & General Purpose
Push-Type Retainer
Head Diameter: 19mm
Stem Length: 16mm
Panel Range: 5.0mm - 7.0mm
Fits into 8mm Hole
GM 2007 - On

UNIT PACKAGE: 25



18308
(3540858)
Black Nylon

Radiator Air Baffle
Push-Type Retainer
Large Head Diameter: 3/4"
Stem Length: 1-1/8"
Fits into 1/4" Hole
Cadillac Eldorado &
Seville 1993-On

UNIT PACKAGE: 25



19239
(GM: 11519949;
Honda: 91512-SX0-003;
Mitsubishi: MU000319)
Black Nylon

Fender, Interior Trim & Washer Tank
Push-Type Retainer
Head Diameter: 20mm
Stem Length: 11mm
Fits into 8mm Hole
Buick, Cadillac, Chevrolet &
GMC 1997 - On

UNIT PACKAGE: 25



22100
(GM: 11612035)
Black Nylon

Front Fender & Body Side Liner
Push-Type Retainer
Head Diameter: 20mm
Stem Length: 12mm
Fits into 8.5mm Hole
Chevrolet Colorado & SS and GMC
Canyon 2014 - On

UNIT PACKAGE: 25